



Garden & Storage

---

**RF2236057**

RECHTS

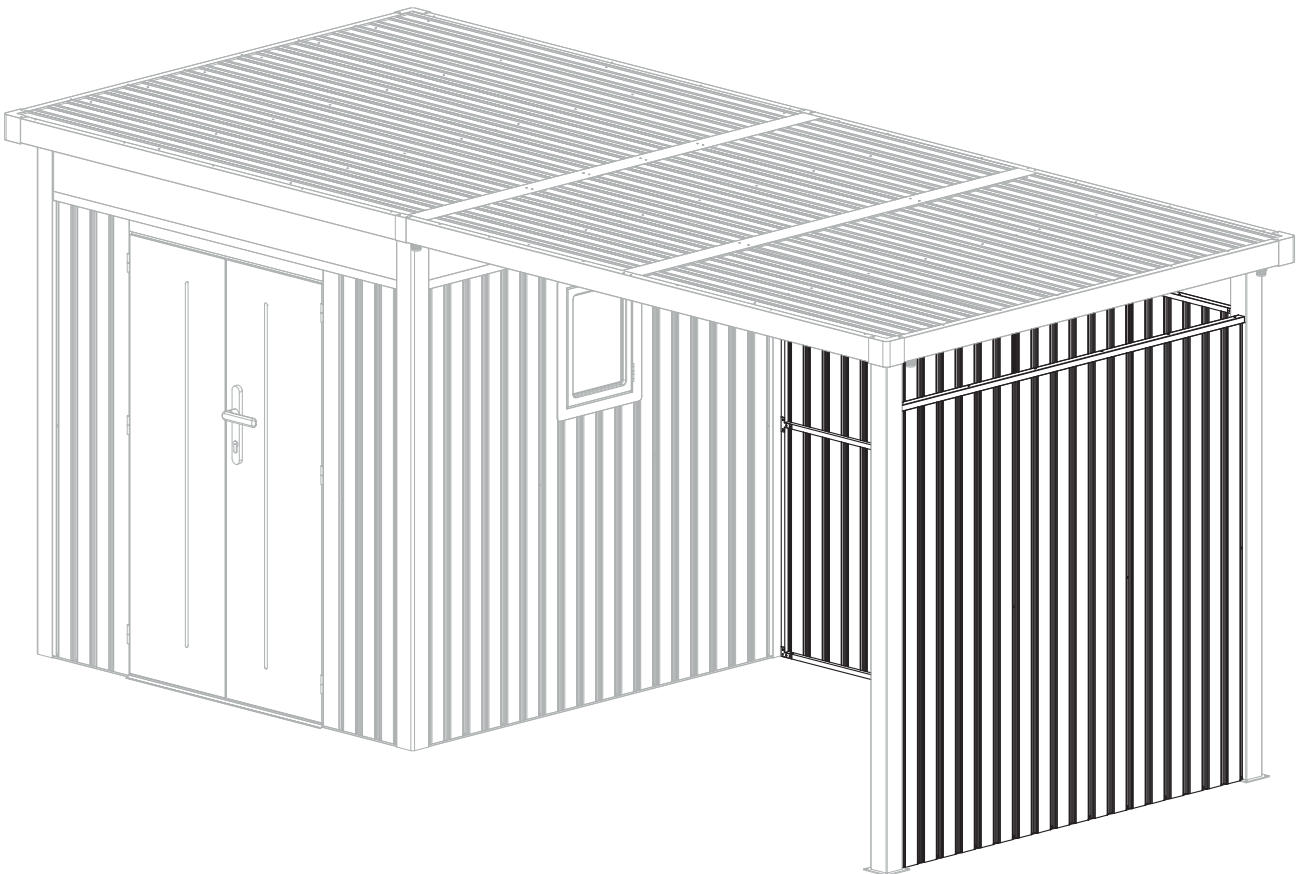

### **Introduction and Safety Precautions:**

Please inspect all parts of your shed package carefully and study the assembly plan and precautions before starting assembly, to ensure a smoother and quicker process. It is recommended to assemble the shed with multiple people (2-3) for better efficiency. Consult the regulations for shed installation in your municipality prior to assembly.

### **Installation Instructions:**

Read the following step-by-step instructions thoroughly before starting assembly to save time and prevent injuries.

### **Placement and Installation:**

Install your garden shed on a stable, level foundation (preferably concrete) to enhance stability and durability against weather conditions. We recommend using the included anchor bolts. Choose a location protected from wind, is dry and with efficient rainwater drainage. This will significantly improve its longevity.

### **List of Tools and Accessories:**

Verify that all necessary tools and parts are complete according to the provided parts list. Remove any plastic protective film before installation. Keep note of label numbers on parts for easy identification during assembly.

### **Guidelines:**

1. Choose a windless and rainless day for shed installation. Have two or more people available for assembly.
2. Wear safety gloves, masks, and long-sleeved clothing to prevent injuries. Be cautious of sharp corners and edges.
3. Ensure children and pets stay away from the assembly area for their safety.
4. Please do not climb onto the roof. Use a ladder to install roof panels. Handle the ladder carefully to maintain a safe environment.

### **Maintenance and Care:**

1. Keep stored items in your garden shed clean. Use soft cloths and water (low amounts of detergent if necessary) for cleaning.
2. This garden shed is not suitable for storing flammable and/or dangerous materials of any sort. Doing so is at your own risk, will void your warranty and waive all responsibilities from the manufacturer/supplier in the case of product issues and/or injury or accident.
3. Check the cleanliness of door profiles to ensure smooth operation. Remove any impurities as needed.
4. Promptly remove snow from the rooftop to prevent any damage. Any damage caused by external influences is not covered by the warranty. Contact your insurance company for assistance.
5. Remember, the garden shed is for storage purposes only and should not be used as a living space.

### **Introductie en Veiligheidsmaatregelen:**

Inspecteer alstublieft alle onderdelen van uw tuinhuis zorgvuldig en bestudeer het montageplan en de voorzorgsmaatregelen voordat u met de montage begint om een soepeler en sneller proces te waarborgen. Het wordt aanbevolen om de schuur met meerdere personen (2-3) te monteren voor een betere efficiëntie. Raadpleeg de voorschriften voor het plaatsen van een tuinhuis in uw gemeente voordat u begint met de montage.

### **Montage-instructies:**

Lees de volgende stapsgewijze instructies grondig door voordat u met montage begint, om tijd te besparen en verwondingen te voorkomen.

### **Plaatsing en Installatie:**

Plaats uw tuinhuis op een stabiele, vlakke en waterpas ondergrond (bij voorkeur beton) om stabiliteit en duurzaamheid tegen weersomstandigheden te verbeteren. Wij raden aan om de bijgeleverde keilbouten te gebruiken. Kies een locatie die beschermd is tegen wind, droog is en efficiënte afwatering heeft voor regenwater. Dit zal de levensduur aanzienlijk verbeteren.

### **Lijst van Gereedschappen en Accessoires:**

Controleer of alle benodigde gereedschappen en onderdelen compleet zijn volgens de meegeleverde onderdelenlijst. Verwijder eventuele plastic beschermfolie voor installatie. Houd de labelnummers op de onderdelen bij, voor eenvoudige identificatie tijdens de montage.

### **Richtlijnen:**

1. Kies een dag zonder wind en regen voor de installatie van het tuinhuis. Zorg ervoor dat er twee of meer personen beschikbaar zijn voor de montage.
2. Draag veiligheidshandschoenen, maskers en kleding met lange mouwen om verwondingen te voorkomen. Wees voorzichtig met scherpe hoeken en randen. Zorg ervoor dat kinderen en huisdieren uit de montagezone blijven voor hun veiligheid.
4. Beklim alstublieft niet het dak. Gebruik een ladder om de dakpanelen te installeren. Gebruik de ladder op een correct en voorzichtig manier om een veilige omgeving te behouden.

### **Onderhoud en Verzorging:**

1. Houd de opgeslagen items in uw tuinschuur schoon. Gebruik zachte doeken en water (eventueel met een kleine hoeveelheid afwasmiddel) voor het schoonmaken.
2. Deze tuinhuis is niet geschikt voor het opslaan van brandbare en/of gevaarlijke stoffen van welke aard dan ook. Het opslaan hiervan is op eigen risico en zal uw garantie ongeldig maken.
3. Controleer de deurprofielen om een soepele werking te garanderen. Verwijder indien nodig eventuele verontreinigingen.
4. Verwijder sneeuw tijdig van het dak om schade te voorkomen. Schade veroorzaakt door externe invloeden valt niet onder de garantie. Neem contact op met uw verzekeringsmaatschappij.
5. Onthoud dat de tuinschuur alleen bedoeld is voor opslagdoeleinden en niet als leefruimte gebruikt mag worden.

### **Einführung und Sicherheitsmaßnahmen:**

Bitte inspizieren Sie alle Teile Ihres Schuppenpakets sorgfältig und studieren Sie den Montageplan und die Vorsichtsmaßnahmen, bevor Sie mit der Montage beginnen, um einen reibungsloseren und schnelleren Prozess zu gewährleisten. Es wird empfohlen, den Schuppen mit mehreren Personen (2-3) für eine bessere Effizienz aufzubauen. Konsultieren Sie die Vorschriften für den Aufbau von Schuppen in Ihrer Gemeinde, bevor Sie mit der Montage beginnen.

### **Montageanleitung:**

Lesen Sie die folgenden schrittweisen Anweisungen gründlich durch, bevor Sie mit der Montage beginnen, um Zeit zu sparen und Verletzungen zu vermeiden.

### **Platzierung und Installation:**

Stellen Sie Ihren Gartenschuppen auf einen stabilen, ebenen Untergrund (vorzugsweise Beton), um Stabilität und Wetterbeständigkeit zu verbessern. Wir empfehlen die Verwendung der mitgelieferten Ankerbolzen. Wählen Sie einen Standort, der windgeschützt, trocken und über effiziente Entwässerung für Regenwasser verfügt. Dies wird die Lebensdauer erheblich verbessern.

### **Werkzeug- und Zubehörliste:**









Stellen Sie sicher, dass alle benötigten Werkzeuge und Teile gemäß der beigefügten Teileliste vollständig sind. Entfernen Sie gegebenenfalls Schutzfolien vor der Installation. Behalten Sie die Etikett nummern der Teile im Auge, um sie während der Montage leicht identifizieren zu können.

### **Richtlinien:**





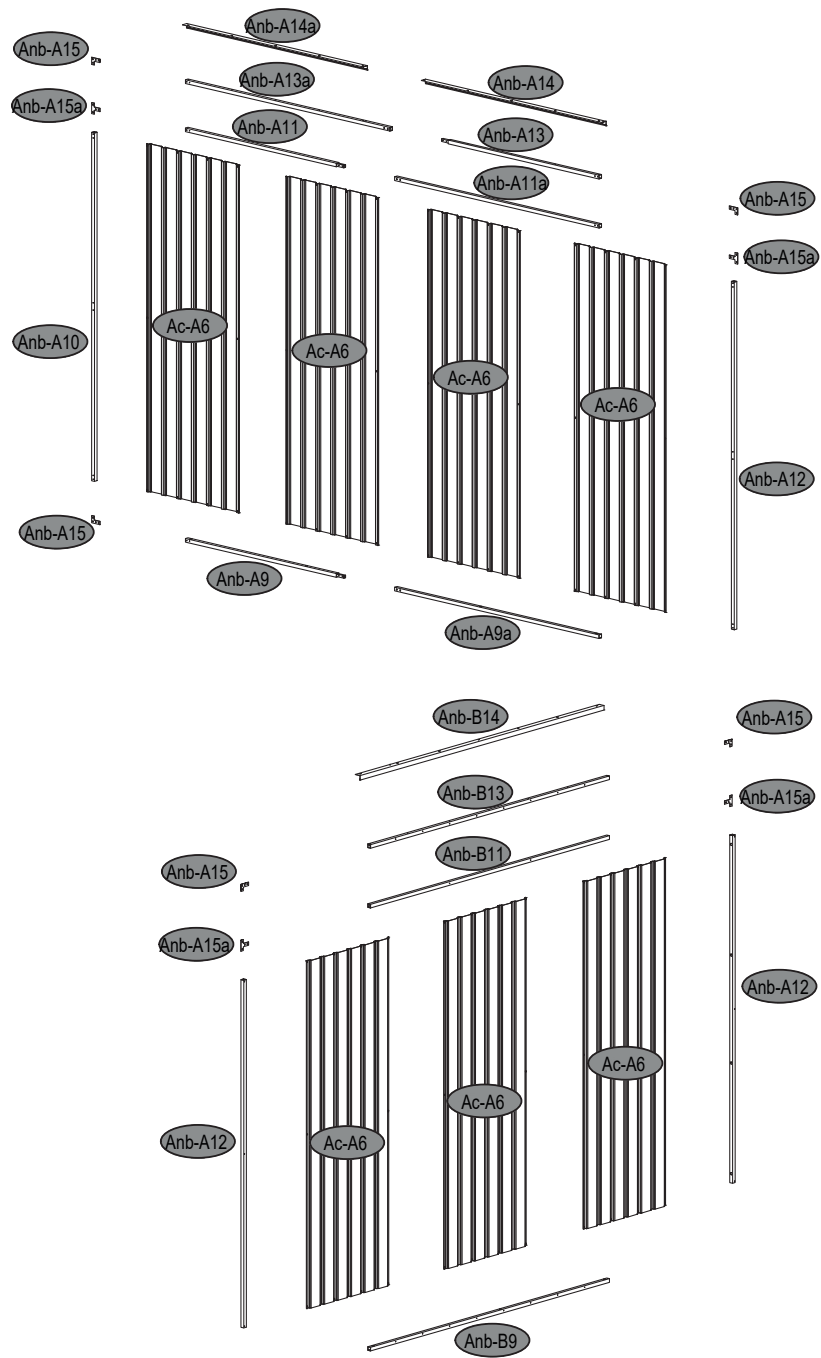

1. Wählen Sie einen Tag ohne Wind und Regen für die Schuppeninstallation aus. Stellen Sie sicher, dass zwei oder mehr Personen für die Montage zur Verfügung stehen.
2. Tragen Sie Sicherheitshandschuhe, Masken und langärmelige Kleidung, um Verletzungen zu vermeiden. Seien Sie vorsichtig mit scharfen Kanten und Ecken.
3. Achten Sie darauf, dass Kinder und Haustiere aus dem Montagebereich fernbleiben, um ihre Sicherheit zu gewährleisten.
4. Betreten Sie bitte nicht das Dach. Verwenden Sie eine Leiter, um die Dachpaneele zu installieren. Handhaben Sie die Leiter vorsichtig, um eine sichere Umgebung zu gewährleisten.

### **Wartung und Pflege:**





1. Halten Sie die in Ihrem Gartenschuppen gelagerten Gegenstände sauber. Verwenden Sie weiche Tücher und Wasser (ggf. mit einer kleinen Menge Spülmittel) zur Reinigung.
2. Dieser Gartenschuppen ist nicht für die Lagerung von brennbaren und/oder gefährlichen Stoffen jeglicher Art geeignet. Die Lagerung solcher Stoffe erfolgt auf eigenes Risiko, was Ihre Garantie ungültig macht und den Hersteller/Lieferanten von jeglicher Verantwortung bei Produktproblemen und/oder Verletzungen oder Unfällen befreit.
3. Überprüfen Sie die Türprofile regelmäßig, um einen reibungslosen Betrieb zu gewährleisten. Entfernen Sie bei Bedarf Verunreinigungen.
4. Entfernen Sie rechtzeitig Schnee vom Dach, um Schäden zu vermeiden. Schäden durch äußere Einflüsse fallen nicht unter die Garantie. Kontaktieren Sie Ihre Versicherungsgesellschaft.
5. Denken Sie daran, dass der Gartenhaus nur zur Aufbewahrung und nicht als Wohnraum genutzt werden darf.

NO.	IMAGE	mm	QTY		NO.	IMAGE	mm	QTY
Anb-A9		1452	x1		Ac-A6		1900	x7
Anb-A9a		1122	x1		Anb-A14		1282	x1
Anb-B9		1885	x1		Anb-A14a		1282	x1
Anb-A10		1904	x1		Anb-B14		1925	x1
Anb-A11		1452	x1		Anb-A15			x5
Anb-A11a		1122	x1		Anb-A15a			x4
Anb-B11		1885	x1		AnbW-C40			x55
Anb-A12		1900	x3		AnbW-C41		ST4x10	x119
Anb-A13		1452	x1		AnbW-C43		ST4.2x13	x16
Anb-A13a		1122	x1		AnbW-C44		ST4x25	x7
Anb-B13		1885	x1					

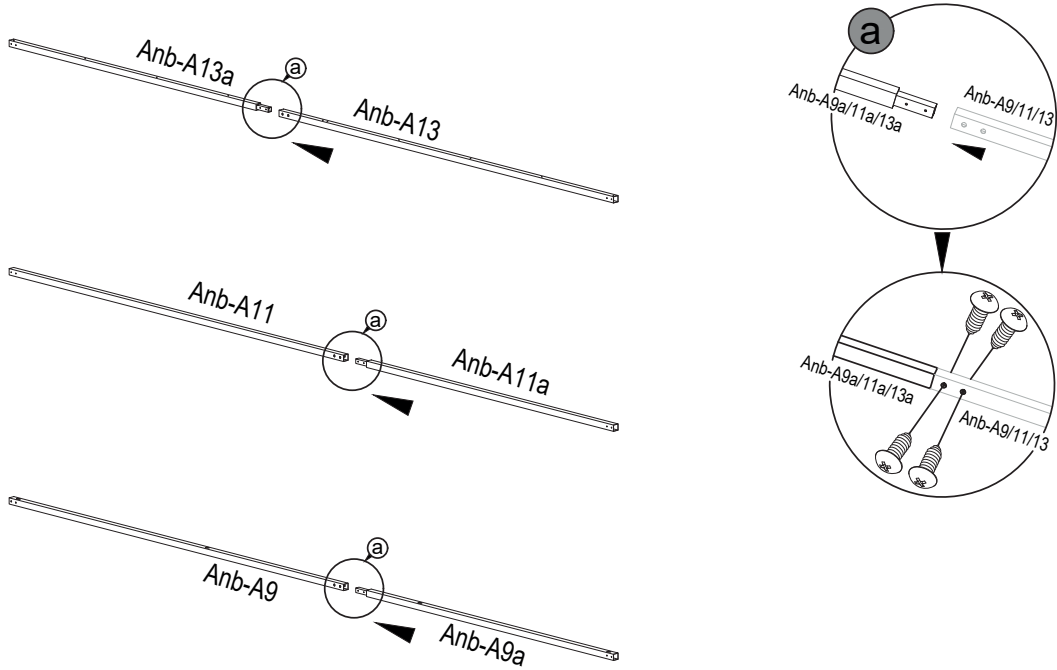

<b>1</b>	 Anb-A9 [x1]	 Anb-A9a [x1]	 Anb-A11 [x1]	 Anb-A11a [x1]	 Anb-A13 [x1]	 Anb-A13a [x1]	 AnbW-C41 [x12]
----------	--	---	---	--	---	--	---



<b>2</b>	 Anb-A12 [x1]	 Anb-A10 [x1]	 Anb-A15 [x3]	 Anb-A15a [x2]	 AnbW-C41 [x20]	
----------	---	---	---	---	---	--

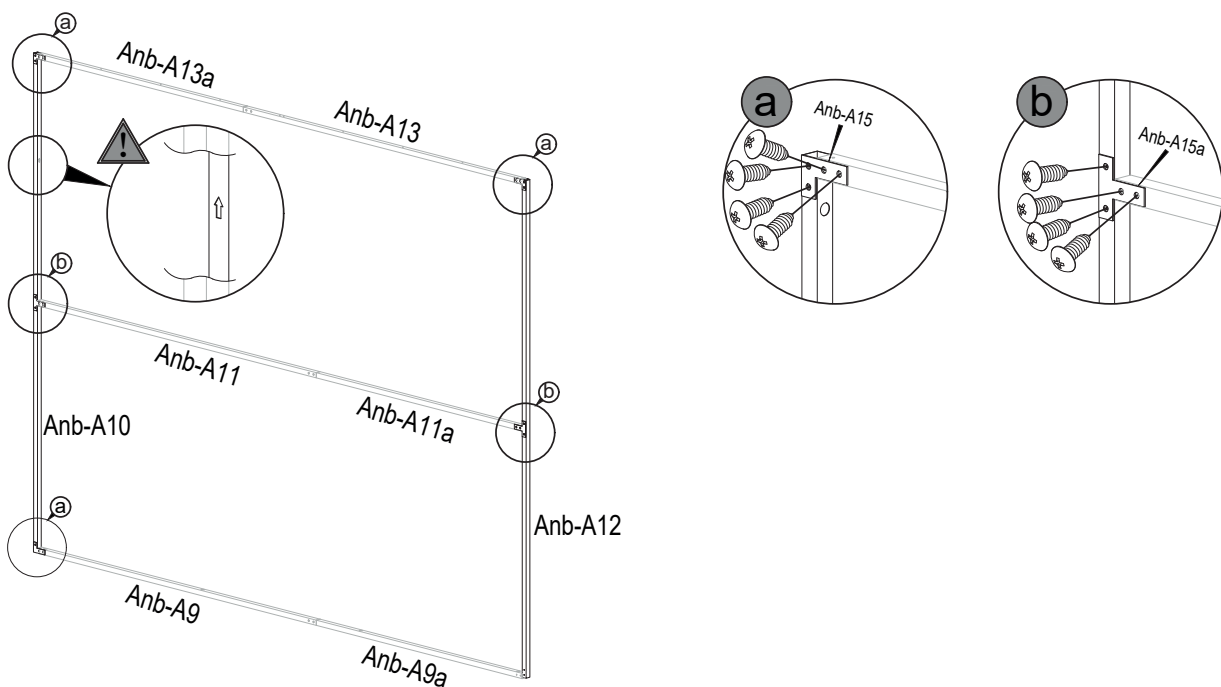

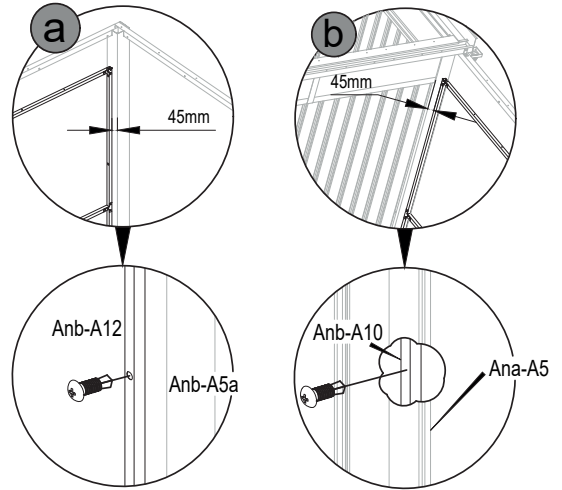
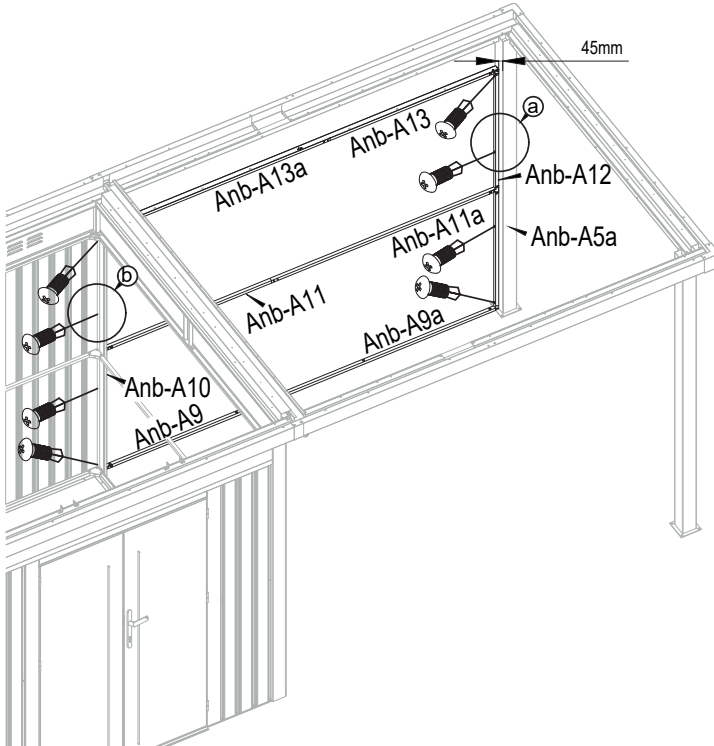

<b>3</b>	 AnbW-C43 [ x8 ]	
----------	--	--



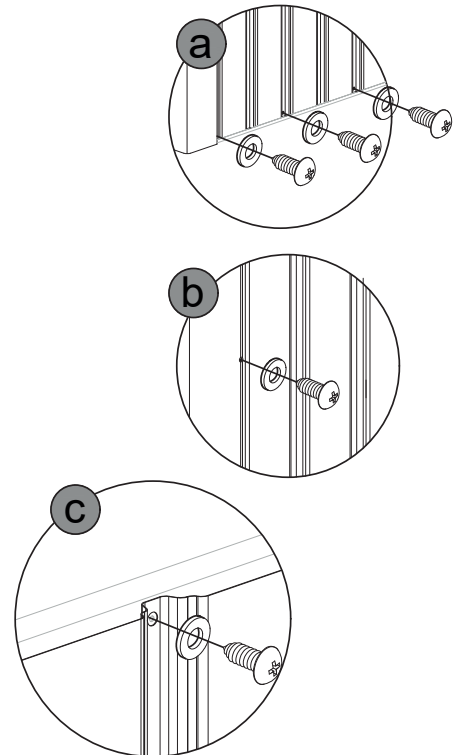
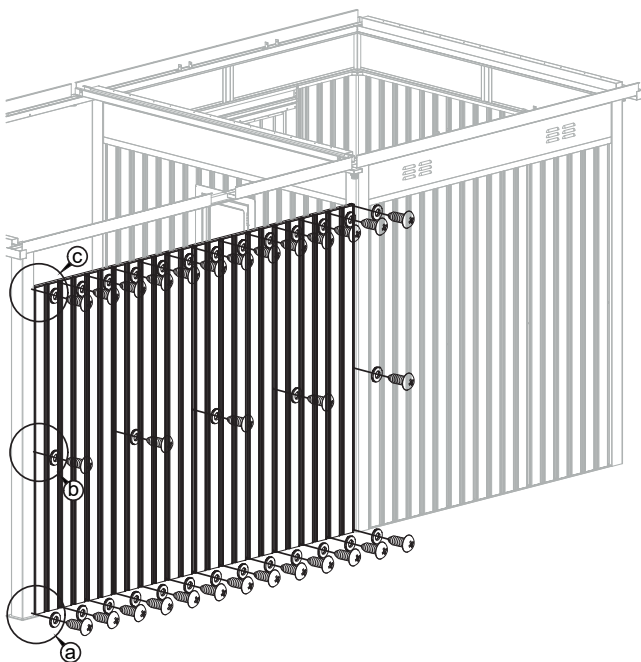





<b>4</b>	 Ac-A6 [ x4 ]	 AnbW-C41 [ x31 ]	 AnbW-C40 [ x31 ]	
----------	---	---	---	--

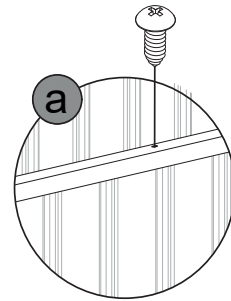
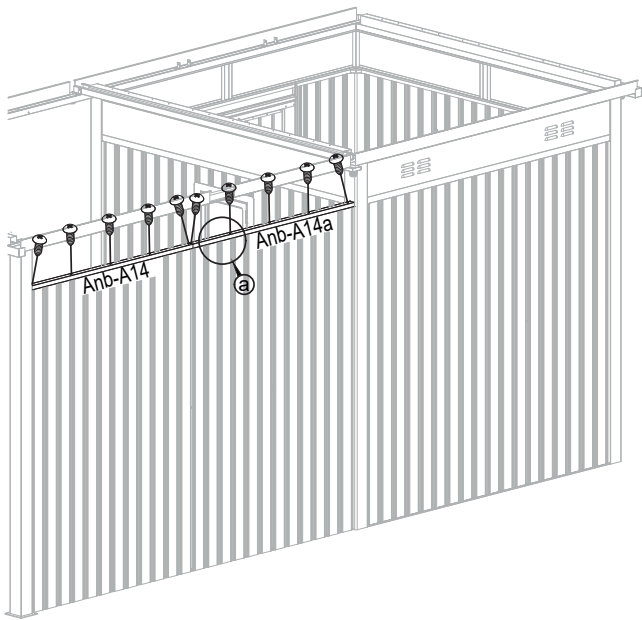



<b>5</b>	 Anb-A14 [x1]	 Anb-A14a [x1]	 AnbW-C41 [x10]	
----------	---	--	---	--



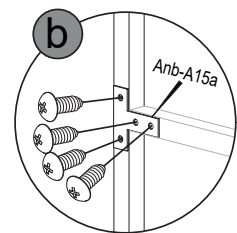
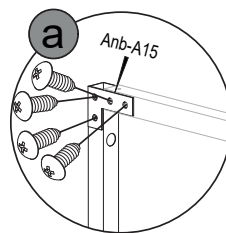
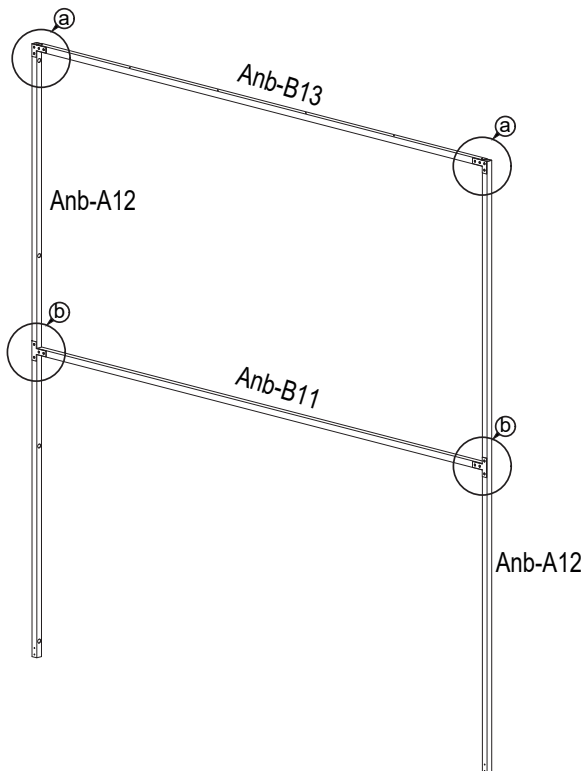

<b>6</b>	 Anb-B11 [x1]	 Anb-B13 [x1]	 Anb-A12 [x2]	 Anb-A15 [x2]	 Anb-A15a [x2]	 AnbW-C41 [x16]	
----------	---	---	---	---	---	---	--

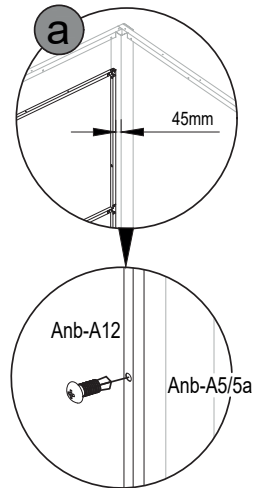
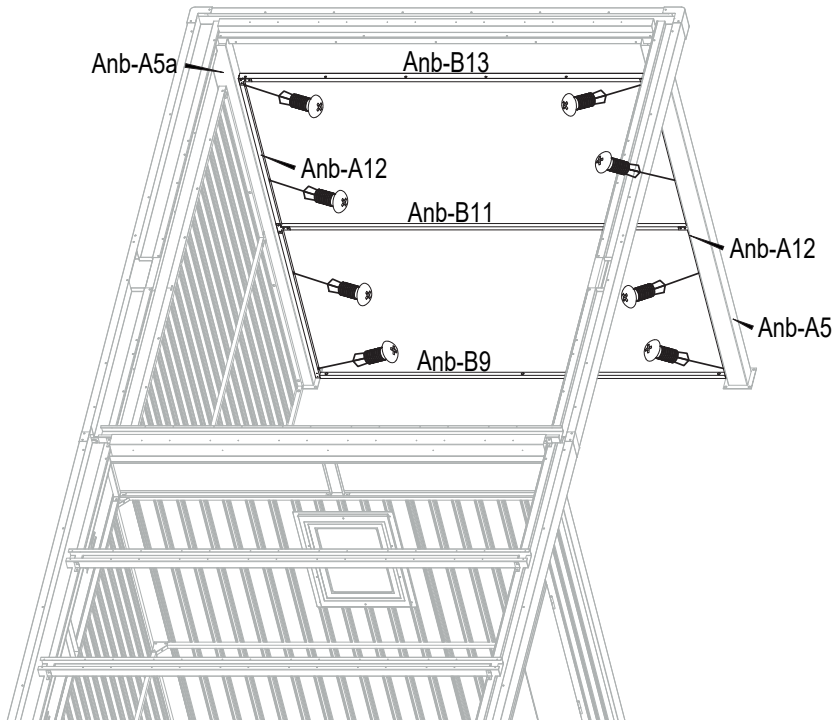

<b>7</b>	 Anb-B9 [x1]	 AnbW-C43 [x8]	
----------	--	--	--



<b>8</b>	 Ac-A6 [x3]	 AnbW-C41 [x24]	 AnbW-C40 [x24]	
----------	---	---	---	--

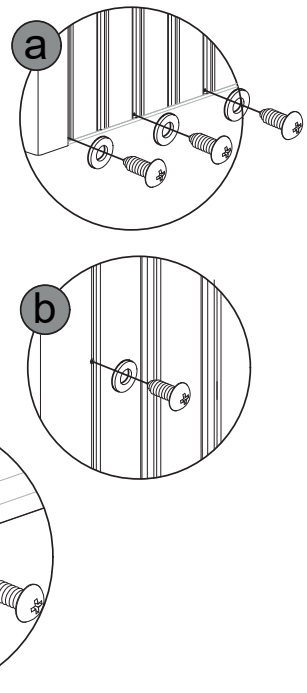
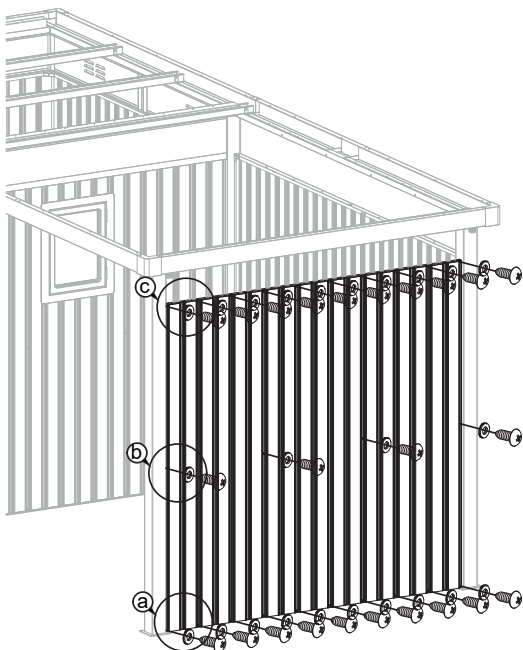

<b>9</b>	 Anb-B14 [x1]	 AnbW-C41 [x6]	
----------	---	--	--

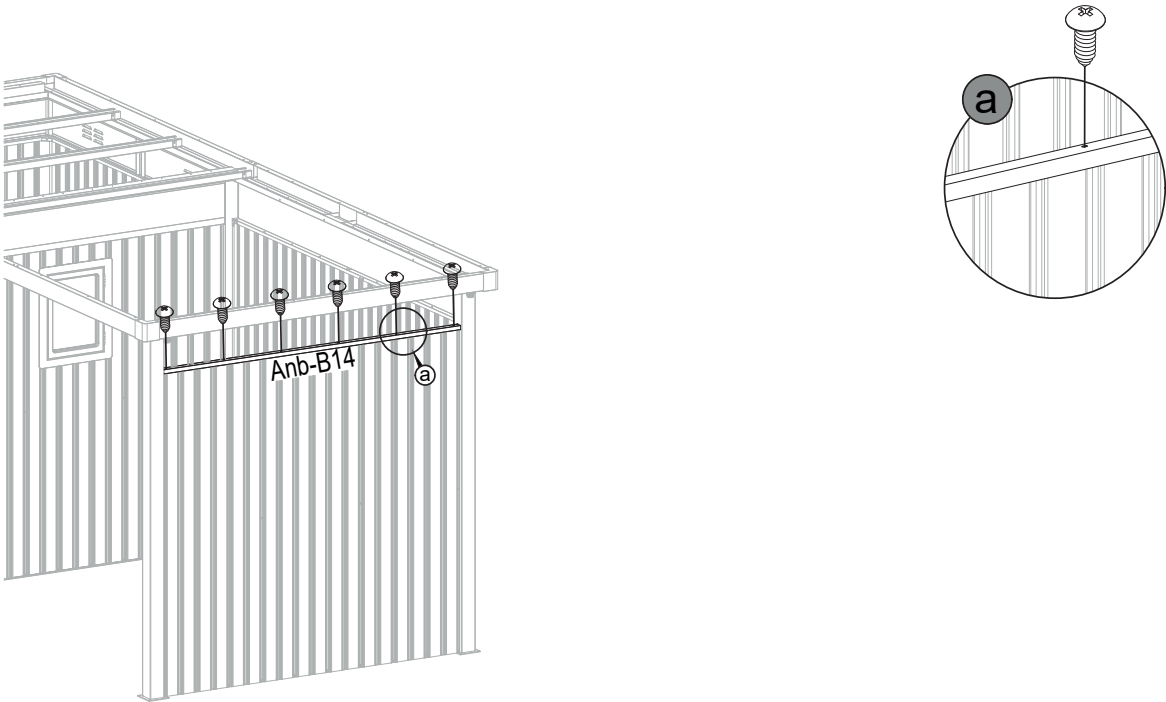

<b>10</b>	 AnbW-C44 [x7]	
-----------	--	--

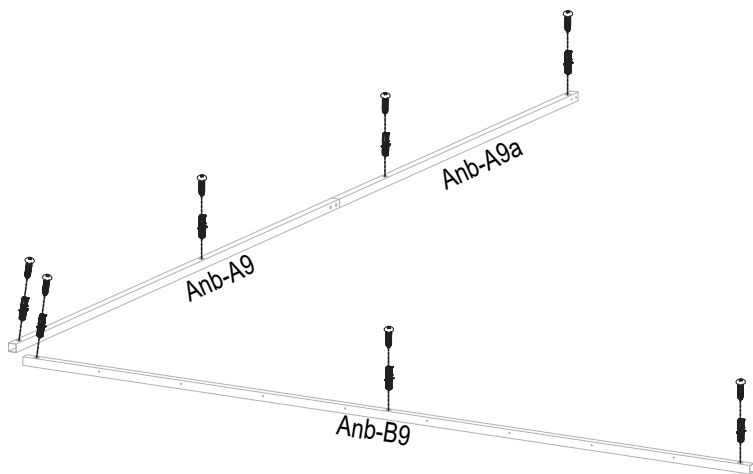
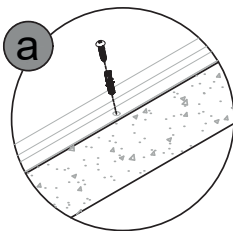
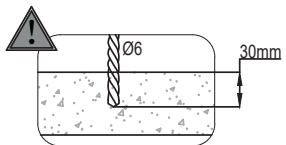



Garden & Storage

---

Witvrouwenbergweg 13B

5711 CN, Someren

Nederland